

Hardware system for 2 sliding doors weighing up to 80 kg (176 lbs.) simultaneously opening to the left and right.

Description

This hardware set permits the simultaneous opening and closing of two-panel doors with a weight up to 80 kg (176 lbs.).

Features of the HAWA-Symmetric 80/Z

- Maximum door weight: 80 kg (176 lbs.)
- Door width: 500–1200 mm (1'7 ¹¹/₁₆"–3'11 ¹/₄")
- Symmetrical opening of two sliding doors
- Fibreglass-reinforced toothed belts guarantee high tensile strength and a low level of expansion
- Offers all the quality benefits of HAWA-Junior 80/Z products
- Allows large openings without bottom guide channels

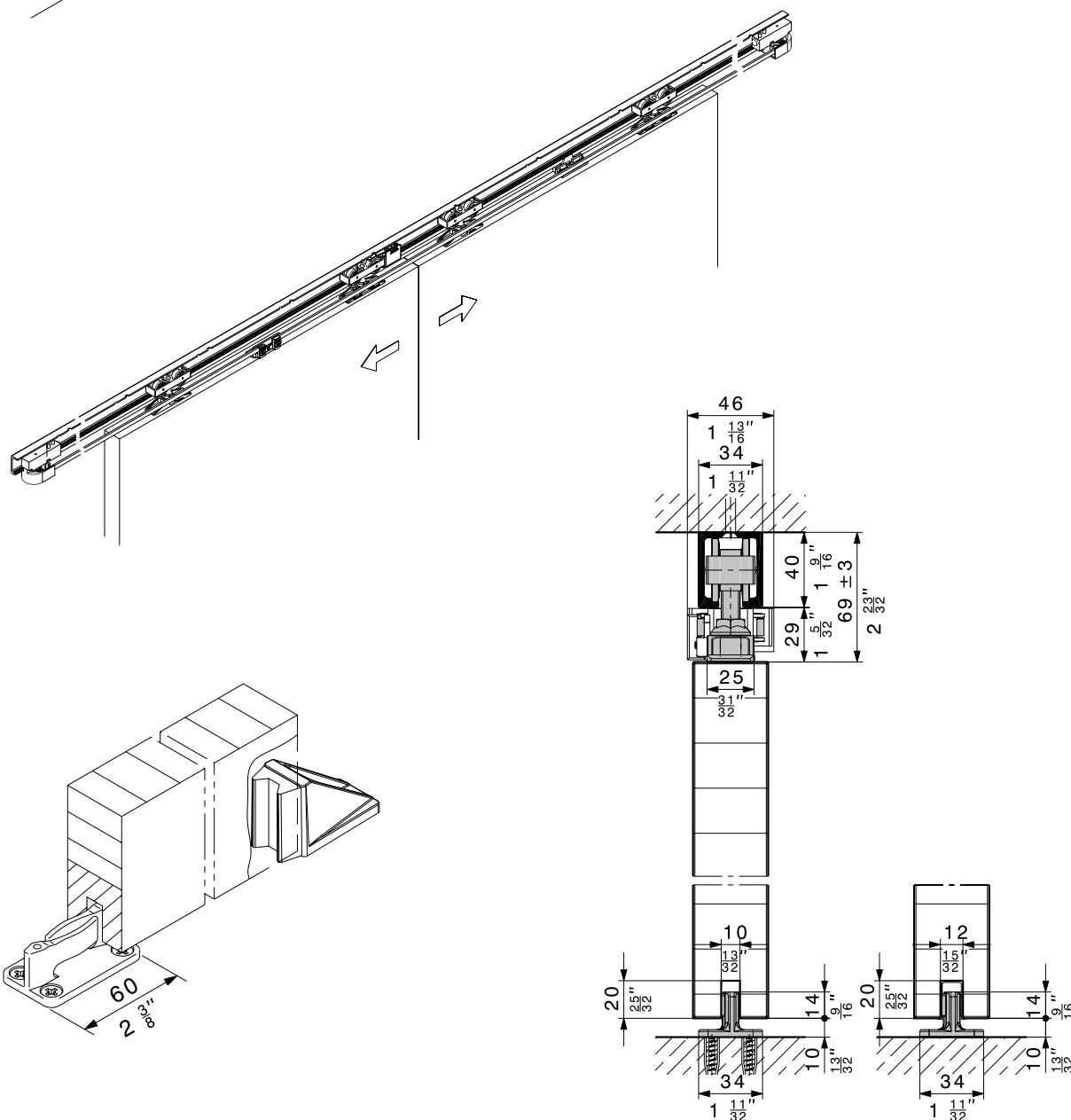











Subject to modification. Metric specifications are exact. Inches are approximate.

Sets for double sliding doors, without running tracks

	code
HAWA-Symmetric 80/Z, complete set	20661
HAWA-Symmetric 80/Z, partial set	20662

Sets comprising

		20661	20662	code
	Guide pulley wheel matching with running track HAWA-Junior 80	2	2	20653
	Toothed belt lock for manual systems	1	1	20352
	Driver, laterally adjustable for manual systems	1	1	20353
	Toothed belt, black, unit 10 m (32'9 ^{5/8} "), fibre glass reinforced	1	1	19668
	Two-wheeled trolley, M10, with plastic wheels	4	-	10407
	Two-way suspension plate, with hanger bolt M10 and fixing screws	4	-	10489
	Track stop, adjustable retaining force	1	-	24497
	Guide, rattle proof, for screw mounting to floor, groove width 10 mm (^{3/8} "), black plastic	2	-	14427
	Screw-on rubber door stop	2	-	10629
	Vertical adjustment pin	1	-	10795

Toothed belt

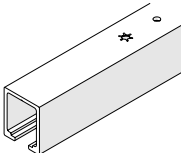

The length of the toothed belt has been calculated for 2 sliding doors with a maximum width of 1200 mm (3'11 ^{1/4}").

Running tracks

Caution: Hole positions vary	mm/inch	code
	1400 (4'7 ^{1/8} ")	10189
	1600 (5'3")	10190
	1800 (5'10 ^{7/8} ")	10191
	2000 (6'6 ^{3/4} ")	10192
	2200 (7'2 ^{5/8} ")	10193
	2500 (8'2 ^{7/16} ")	10194
	3000 (9'10 ^{1/8} ")	18532
	4000 (13'1 ^{1/2} ")	18533
	6000 (19'8 ^{3/16} ")	10186
	cut to size	10188

Running track, alu plain anodized, predrilled

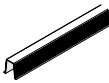
Accessories

Caution: Minor differences in colour are possible		code
	Guide profile, plastic black, 1300 mm (4'3 ^{3/16} "), groove mounted, set of 10 pieces	14540
	Cover cap for running track, metal, suitable to both sides, 1 piece	dull chromium finish 24956
	Bottom door stop with centering assembly	dull chromium finish 20773
		stainless steel effect 21473

Further accessories: → pages 68 – 83

Order specifications

- Quantity of complete set
- Quantity of partial set
- Quantity of HAWA-Junior 80/Z-sets
- Length of running tracks

Planning/installation

For planning and execution please use the installation instructions code 20663. (→ www.hawa.ch → HAWA-Productfinder)

HAWA-Symmetric hardware may also be used for glass or metal sliding doors. Please request the corresponding documentation.